

EUROPRO PUMPS-MY19



Elettropompe centrifughe per piscina

Centrifugal motor pumps for pools



CAMPO DI UTILIZZO

Sviluppata per la circolazione e la filtrazione di acqua nelle piscine domestiche e residenziali. Idonea anche in applicazioni particolari dove è richiesta la movimentazione di liquidi aggressivi. Idonea per acqua salata. Nuovo coperchio.



CONTEXT OF USE

Developed to improve the circulation and filtration of domestic and residential pools. It is suitable also for specific applications where aggressive liquids are used. Suitable for salted water. New lid.



DESCRIZIONE

Corpo pompa e ghiera prefiltro in tecnopolimero rinforzato con fibre di vetro. Coperchio prefiltro in policarbonato trasparente e antiossidazione per garantire una visibilità costante nel tempo. Filtro in nylon. Girante in tecnopolimero rinforzata con fibre di vetro, sviluppata per garantire una totale copertura e isolamento dell'albero motore dal liquido pompato. Diffusore in tecnopolimero rinforzato. Tenuta meccanica in carbone/allumina/NBR/AISI 316. O-ring corpo pompa in NBR, viteria e ghiera di rinforzo in acciaio AISI 304. Tappi di carico e scarico a farfalla che non richiedono l'utilizzo di utensili per la rimozione e il riposizionamento. Grado di protezione del motore e della morsettiera: IP 55. Classe di isolamento: F. Tensioni di serie: monofase 220/240V - 50 Hz. Trifase 230/400V - 50 Hz. Campo di funzionamento: fino a 42 m³/h con prevalenza fino a 22 m. Liquido pompato: acqua pulita o leggermente sporca con corpi solidi in sospensione, fibre lunghe; acqua particolarmente aggressiva con alte percentuali di cloro/bromo e PHMB (Poli Esametilene Biguanide) o acqua trattata con processo cloro elettrolisi. Campo di temperatura del liquido: fino a 60° C. Massima temperatura ambiente: +50°C. Massima pressione d'esercizio: 2,5 bar. Installazione: fissa o portatile in posizione orizzontale.



DESCRIPTION

Pump body and pre-filter ring nut in techno-polymer reinforced with glass fibres. Pre-filter lid in transparent and antioxidant polycarbonate that guarantees a long-term visibility. Nylon filter. Techno-polymer impeller reinforced with glass fibres, developed to perfectly protect and insulate the shaft from the liquid pumped in. Diffuser in reinforced techno-polymer. Mechanic seal in carbon/aluminium oxide/NBR/AISI 316. Pump body O-ring in NBR, reinforcement screws and ring nuts in AISI 304 steel. Butterfly charge/discharge valves that do not require special tools to be removed/refitted. Motor and terminal box protection class: IP 55. Insulation class: Series voltage: single-phase 220/240V - 50 Hz. Three-phase 230/400V - 50 Hz. Range of operation: up to 42 cu. m/h with prevalence up to 22 m. Liquid pumped in: clean or slightly dirty water with solid bodies or long fibres in suspension; aggressive water with high percentages of chlorine/bromine and PHMB (Polyhexamethylene biguanide) or chlorine-electrolysis treated waters. Liquid operating temperature: up to 60° C. Maximum surrounding temperature: +50 °C. Max. operating pressure: 2.5 bar. Installation: fixed or portable, in horizontal position.

Codice Code	Descrizione Description	Potenza Nominale Nominal Power	Assorbimento Max A Max Current A	Alimentazione Power supply	Portata Flow-rate			Prezzo Price
		(HP-kW)	A		10mt.	12mt.	14mt.	
100100321N	Europro	0,5 HP - 0,33 kW	4,2	1 - x 220 - 240 V	10	6	-	€
100100322N	Europro	0,75 HP - 0,5 kW	5,0	1 - x 220 - 240 V	18	10	-	
100100323N	Europro	1,0 HP - 0,75 kW	6,3	1 - x 220 - 240 V	23	19	13	
100100324N	Europro	1,5 HP - 1,1 kW	7,0	1 - x 220 - 240 V	23	19	12	
100100325N	Europro	2,0 HP - 1,5 kW	8,6	1 - x 220 - 240 V	28	26	21	
100100326N	Europro	3,0 HP - 2,2 kW	12,0	1 - x 220 - 240 V	40	37	32	
100100332N	Europro	0,75 HP - 0,5 kW	3,2-2,0	3 - x 230-400 V	10	6	-	
100100333N	Europro	1,0 HP - 0,75 kW	4,0-2,4	3 - x 230-400 V	18	10	-	
100100334N	Europro	1,5 HP - 1,1 kW	6,5-3,7	3 - x 230-400 V	23	19	13	
100100335N	Europro	2,0 HP - 1,5 kW	7,2-4,0	3 - x 230-400 V	28	26	21	
100100336N	Europro	3,0 HP - 2,2 kW	8,75-5,0	3 - x 230-400 V	40	37	32	

01 > FILTRAZIONE-pompe FILTRATION-pumps

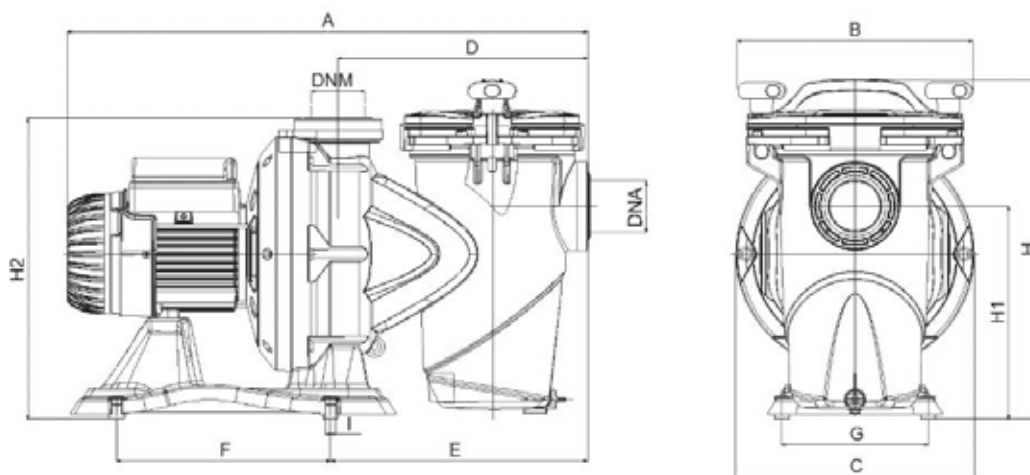

Descrizione Description	Dimensioni/ Dimensions												DNA	DNM	Imballo Packaging (mm)	Peso Weight (Kg)	N° X PALLET
	A	B	C	D	E	F	G	H	HI	H2	I	L					
100100321N	536	242	242	257	265	220	150	351	222	314	11	6,5	2"	2"	600X360X400	16	8
100100322N	552	242	245	257	265	220	150	351	222	314	11	6,5	2"	2"	600X360X400	16,5	8
100100323N	552	242	245	257	265	220	150	351	222	314	11	6,5	2"	2"	600X360X400	17	8
100100324N	574	250	290	267	274	220	150	387	258	350	11	6,5	2"	2"	720X350X430	22	6
100100325N	648	250	290	267	274	220	150	387	258	350	11	6,5	2"	2"	720X350X430	24	6
100100326N	648	252	290	267	274	220	150	387	258	350	11	6,5	2"	2"	720X350X430	24,5	6
100100332N	552	242	245	257	265	220	150	351	222	314	11	6,5	2"	2"	600X360X400	16,5	8
100100333N	552	242	245	257	265	220	150	351	222	314	11	6,5	2"	2"	600X360X400	17	8
100100334N	574	250	290	267	274	220	150	387	258	350	11	6,5	2"	2"	720X350X430	22	6
100100335N	574	250	290	267	274	220	150	387	258	350	11	6,5	2"	2"	720X350X430	22	6
100100336N	648	252	290	267	274	220	150	387	258	350	11	6,5	2"	2"	720X350X430	24,5	6

MODELLO / MODEL: 0,5 HP

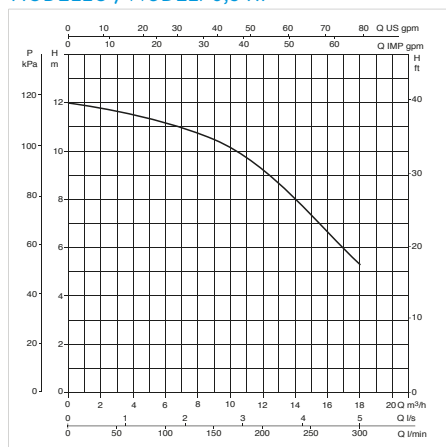

MODELLO / MODEL: 0,75 HP

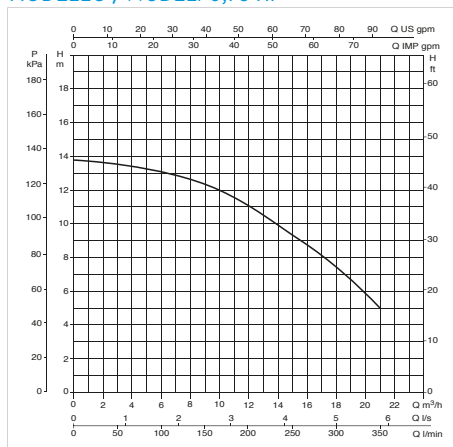

MODELLO / MODEL: 1,0 HP

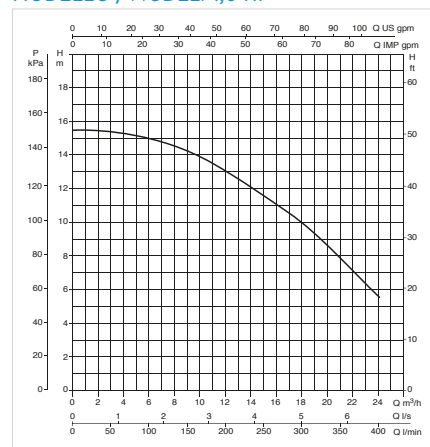

MODELLO / MODEL: 1,5 HP

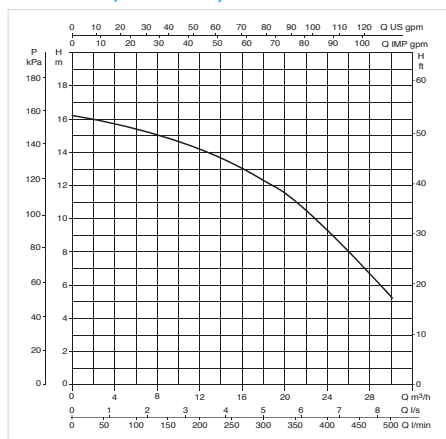

MODELLO / MODEL: 2,0 HP

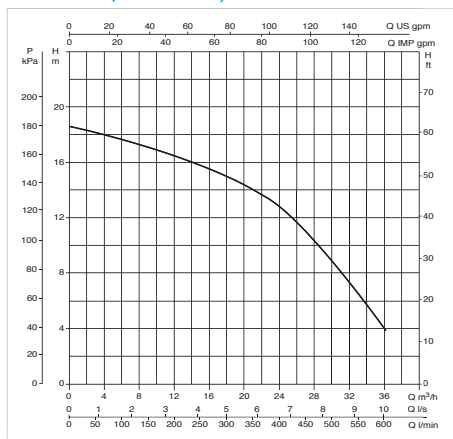

MODELLO / MODEL: 3,0 HP

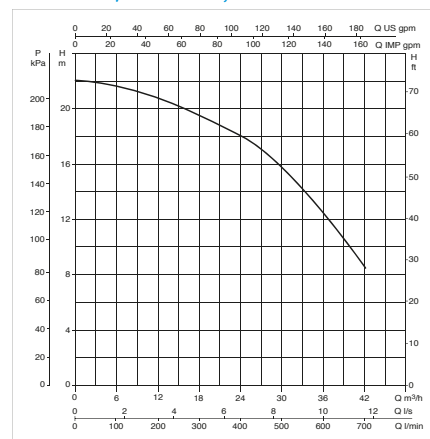

EUROPRO PUMPS-MY19

